

**Sun room awnings from Griesser.  
WGM 1030**





### Sun room awning for smaller glass surfaces

To prevent sun rooms turning into saunas, we would recommend using suitable sun protection. As a specialist in sun protection systems, Griesser set itself complex architectural standards and developed the WGM 1030. With a maximum fabric area of 16 m<sup>2</sup>, it is suited to smaller sun rooms. The high-quality backpull system consisting of textile ropes in the front bar guarantees that the fabric is permanently tensioned.

#### *Flat unit*

The WGM 1030 flat unit is available as a single and multiple panel system (up to four panels).



The WGM 1030 as a flat unit.

#### Special installation

##### *Roof ridge installation*

Additional retaining brackets are available for the WGM 1030 in locations exposed to the wind (on the roof ridge). This option is available for both the flat and solar bent version.



The roof ridge installation with additional retaining brackets.

#### Servicing and maintenance

Sun room awnings should be cleaned and checked on a regular basis. We would recommend using the Griesser StorenService®: Tel 0848 888 111 (in Switzerland).



The tensioning system



The support feet



## Convincing technology in detail

### *The tensioning system*

The service technician has fabric tensioning under control in the blink of an eye using a socket wrench. The high-quality textile rope system, integrated in the front bar, ensures that the fabric is permanently tensioned.

### *The side caps*

The modern and elegant design means that the side caps only project 5.5 mm.

### *The carriage*

Precision rollers radically reduce roll resistance, making child's play of retracting and extending.

### *The coupling system*

The intelligent solution positions the fabrics at precisely the same level. After all, fabrics which are extended and retracted simultaneously simply look more attractive.

### *The support feet*

The choice of a huge range of support feet enables you to master even the most complex installation situations. They need simply be secured to the transport profiles as the box is self-supporting.

### *The caps*

These are made from high-quality cast aluminum and elegantly round off the WGM 1030 transport profiles. They match the side caps in design and color.

### *Water protection*

In the case of driving rain, the integrated protective brushes, located in both the roof and floor of the box, prevent water entering the box.

### *The rain channel in the front bar*

If the WGM 1030 does get caught in the rain, the rainwater runs to the sides in a controlled manner – just like a real roof.

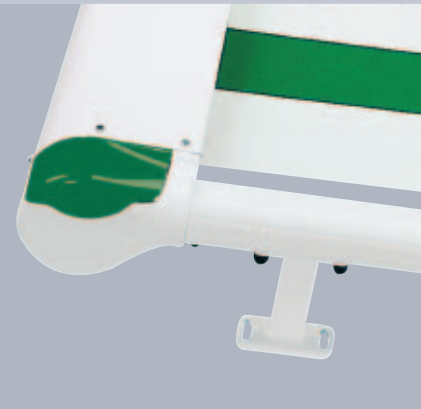

The side caps



The caps



The carriage



Water protection



The coupling system



The rain channel in the front bar

**WGM 1030 flat unit**

- Single panel systems
- Multiple panel systems, up to four panels
- Griesser Collection acrylic materials and Soltis gauze

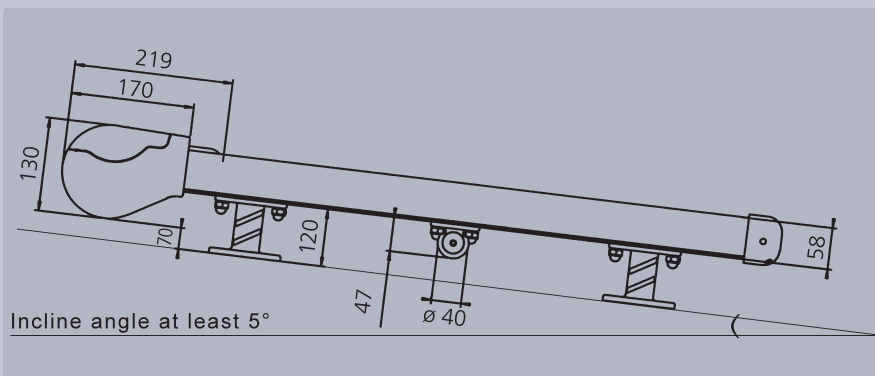
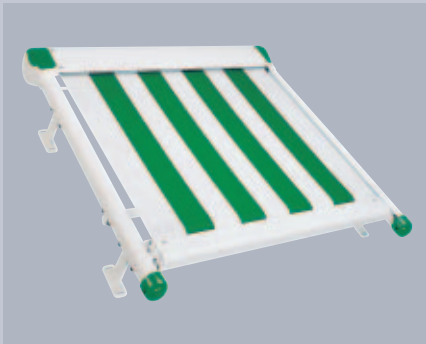

*Side view of WGM 1030-0-1-1*

Single panel flat unit with a motor and a support foot height of 120 mm. Any opening windows, rain channels etc. should be taken into account when determining the installation height.

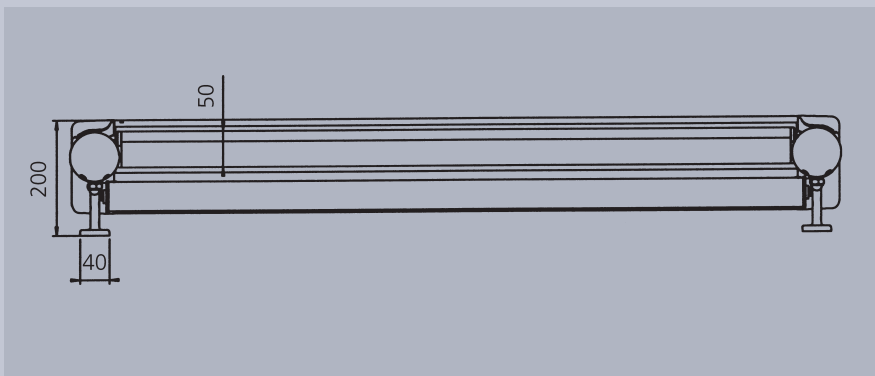





*Front view of WGM 1030-0-1-1*

Single panel flat unit with a motor and a support foot height of 120 mm.



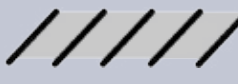

## WGM 1030 limit dimensions

The flat unit with acrylic fabrics.

Number of units	Type 1030	Panels	Motor	max. projection in cm	Dimension between center lines from - to in cm	Width of panel min. - max. in cm
	0-1-1	1	1	- 200	78 - 450	
	0-1-1	1	1	201 - 300	85 - 450	
	0-1-1	1	1	301 - 400	140 - 450	
	0-1-1	1	1	401 - 500	150 - 400	
	0-2-1	2	1	-200	156 - 900	78 - 450
	0-2-1	2	1	201 - 300	170 - 900	85 - 450
	0-2-1	2	1	301 - 400	280 - 900	140 - 450
	0-2-1	2	1	401 - 500	300 - 800	150 - 400
	0-2-2	2	2	-200	156 - 900	78 - 450
	0-2-2	2	2	201 - 300	170 - 900	85 - 450
	0-2-2	2	2	301 - 400	280 - 900	140 - 450
	0-2-2	2	2	401 - 500	300 - 800	150 - 400
	0-3-2	3	2	- 200	234 - 1350	78 - 450
	0-3-2	3	2	201 - 300	255 - 1350	85 - 450
	0-3-2	3	2	301 - 400	420 - 1350	140 - 450
	0-3-2	3	2	401 - 500	450 - 1200	150 - 400
	0-4-2	4	2	- 200	312 - 1800	78 - 450
	0-4-2	4	2	201 - 300	340 - 1800	85 - 450
	0-4-2	4	2	301 - 400	560 - 1800	140 - 450
	0-4-2	4	2	401 - 500	600 - 1600	150 - 400

## WGM 1030 limit dimensions

The flat unit with Soltis fabrics.

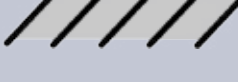
Number of units	Type 1030	Panels	Motor	max. projection in cm	Dimension between center lines from - to in cm	Width of panel min. - max. in cm
	0-1-1	1	1	- 100	78 - 450	
	0-1-1	1	1	101 - 150	85 - 450	
	0-1-1	1	1	151 - 250	150 - 450	
	0-1-1	1	1	251 - 350	170 - 450	
	0-2-1	2	1	-100	156 - 900	78 - 450
	0-2-1	2	1	101 - 150	170 - 900	85 - 450
	0-2-1	2	1	151 - 250	300 - 900	150 - 450
	0-2-1	2	1	251 - 350	340 - 900	170 - 450
	0-2-2	2	2	-100	156 - 900	78 - 450
	0-2-2	2	2	101 - 150	170 - 900	85 - 450
	0-2-2	2	2	151 - 250	300 - 900	150 - 450
	0-2-2	2	2	251 - 350	340 - 900	170 - 450
	0-3-2	3	2	- 100	234 - 1350	78 - 450
	0-3-2	3	2	101 - 150	255 - 1350	85 - 450
	0-3-2	3	2	151 - 250	450 - 1350	150 - 450
	0-3-2	3	2	251 - 350	510 - 1350	170 - 450
	0-4-2	4	2	- 100	312 - 1800	78 - 450
	0-4-2	4	2	101 - 150	340 - 1800	85 - 450
	0-4-2	4	2	151 - 250	600 - 1800	150 - 450
	0-4-2	4	2	251 - 350	680 - 1800	170 - 450

## Design description

### System

Transport profile made from extruded aluminum, with groove for guiding carriage and tensioning rope. Transport profile 52 × 58 mm, double transport profile 94 × 58 mm. Fastening of transport profile with standard support feet on the customer's substructure. Front bar made from extruded aluminum, with integrated tensioning system for optimum material tensioning. Tensioning cable can be quietly wound up in a controlled manner. Spacer pipe made from extruded aluminum. Fabric spindle made from galvanized sheet steel. Cover made from extruded aluminum, two-part.

### Colors

#### Basic

Aluminium (RAL 9006/VSR 140) or White (RAL 9016).

#### GriColors (for an additional charge)

The GriColors range includes 100 color shades in four collections, Glass & Stone, Sun & Fire, Water & Moss and Earth & Wood – from cool white and sunny red to natural blue and earthy brown.

## Fabric collections

### Collection Moments

Awning fabric made from 100% acrylic fibers, according to collection available.

### Collection Soltis 86/92

Soltis 92 (for an additional charge).

Gauze fabric made from highly tear-resistant polyester, according to collection available.

## Planning tips and operating instructions

- The solar shading systems should be retracted if it is windy.
- The systems must not be operated if there is a risk of ice.
- The systems must be accessible for maintenance work.
- Observe the VSR data sheets or information in EN 13561 wind classes.

For more information about our services and products, go to [www.griessergroup.com](http://www.griessergroup.com).

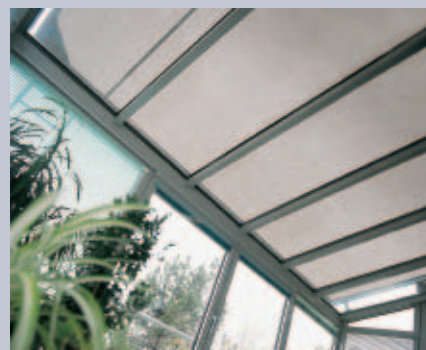

## Your partner

Subject to change without prior notice